

AquaLife 2014

Drinking Water – analysis of bacterial contamination

content

Goals

concept

2-phase filtration module

Lysation of biological contaminants

Detector based on ATP-Assay

First test run in RWW water works

Additional sensor for PCR-Test

General purpose

Technological platform for analysis of drinking water samples and detection of pathogen contaminants in real time.

- Water analysis
 - Module for concentrating the sample
 - Integration of sensitive tests for pathogen detection
 - Development of a device concept for Online Analysis

Possible concepts

The first considerations included different solutions for concentrating germs from water samples.

- Common concepts
 - Throughput centrifugation
 - Centrifugal filtration
 - Dead-End-Filtration
 - Cross-Flow-Filtration

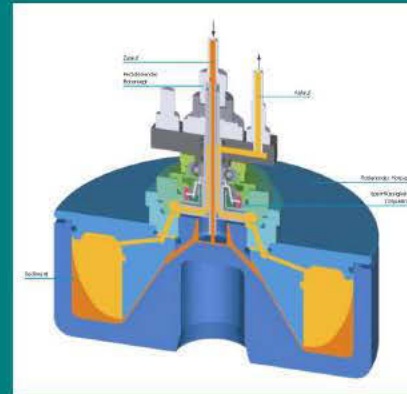

Finding the right solution

The choice fell to filtration methods. Two concepts were built.

- Crossflow-Filtration

Good relation between sample and concentrate volume – very undefined yield rate.

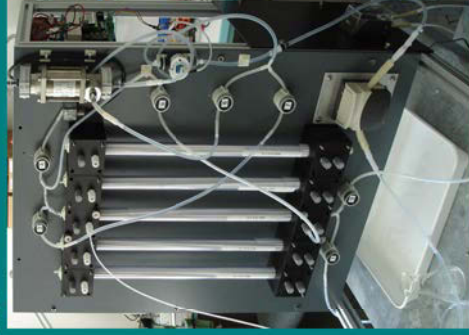

- Dead-End-Filtration

Very defined and well controllable process – concentrate factor can be easily calculated – not continuous.

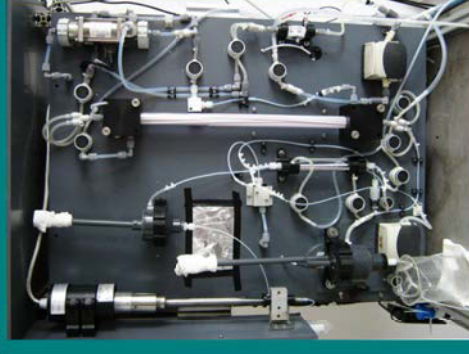

Technical concept

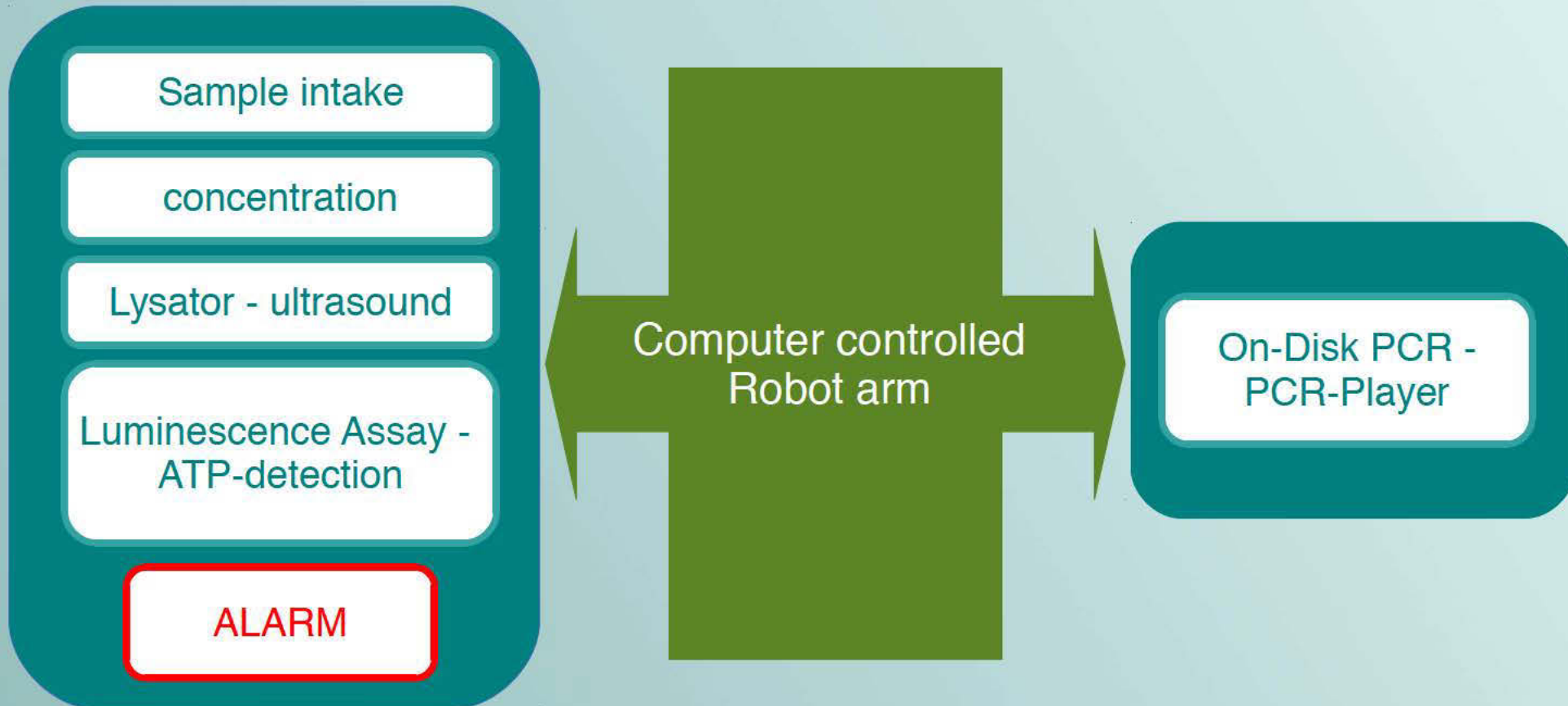

goals

concept

2-phase filtration module

Lysation of biological contaminants

Detector based on ATP-Assay

First test run in RWW water works

Additional sensor for PCR-Test

Filtration module – 1. and 2. stage

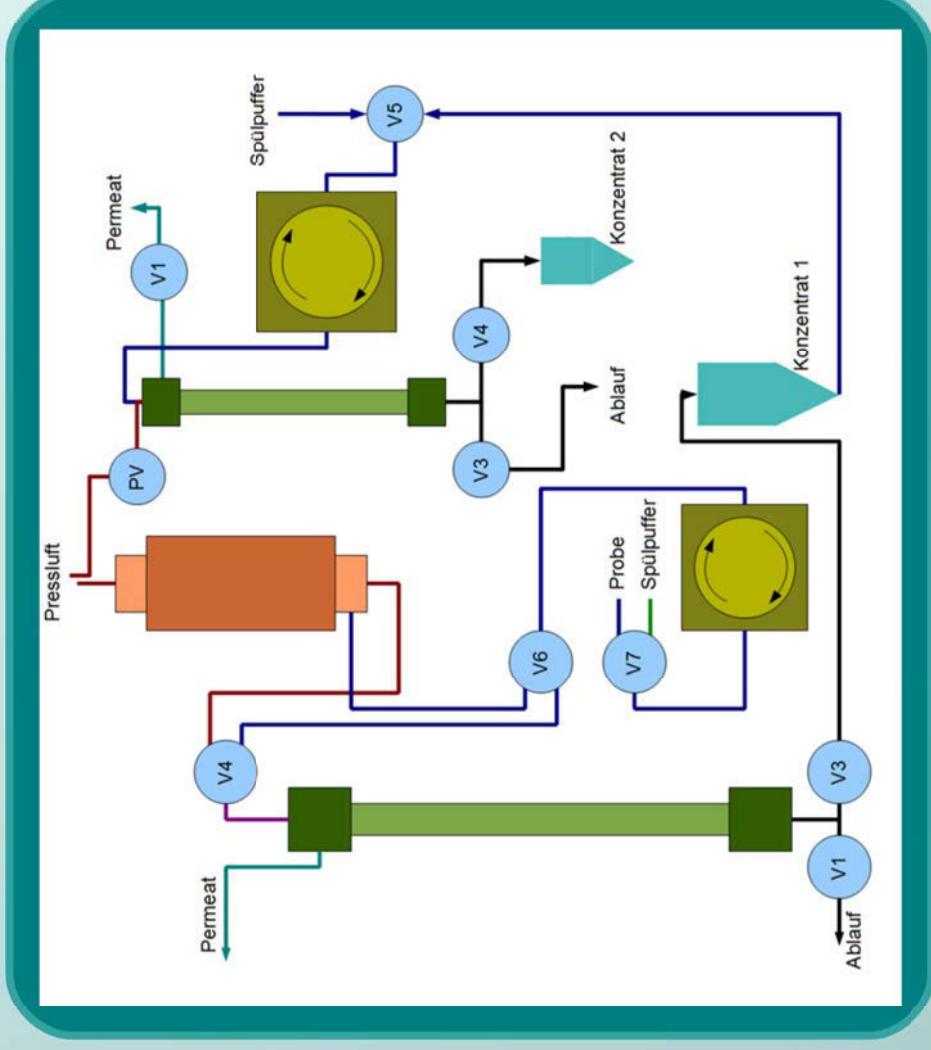
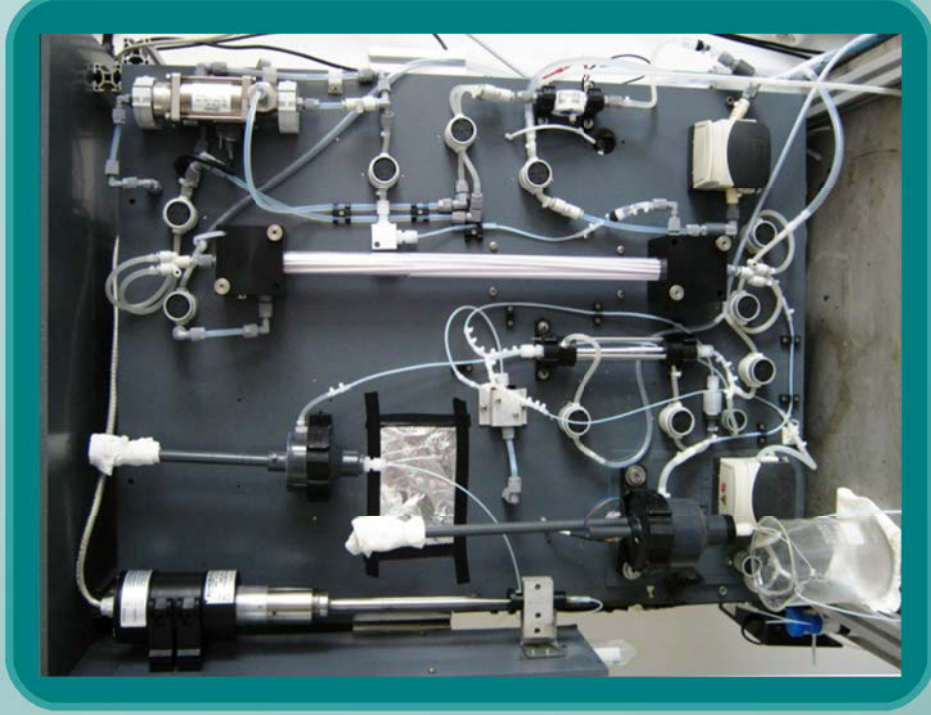

Parameter – 1. and 2. stage

Input volume

10 – 100L sample volume

Output volume

5 – 7ml concentrate

concentration

Around factor 2000

duration

30min for 10L

Retrieval rate

>68% for *E.coli*

Ablauf

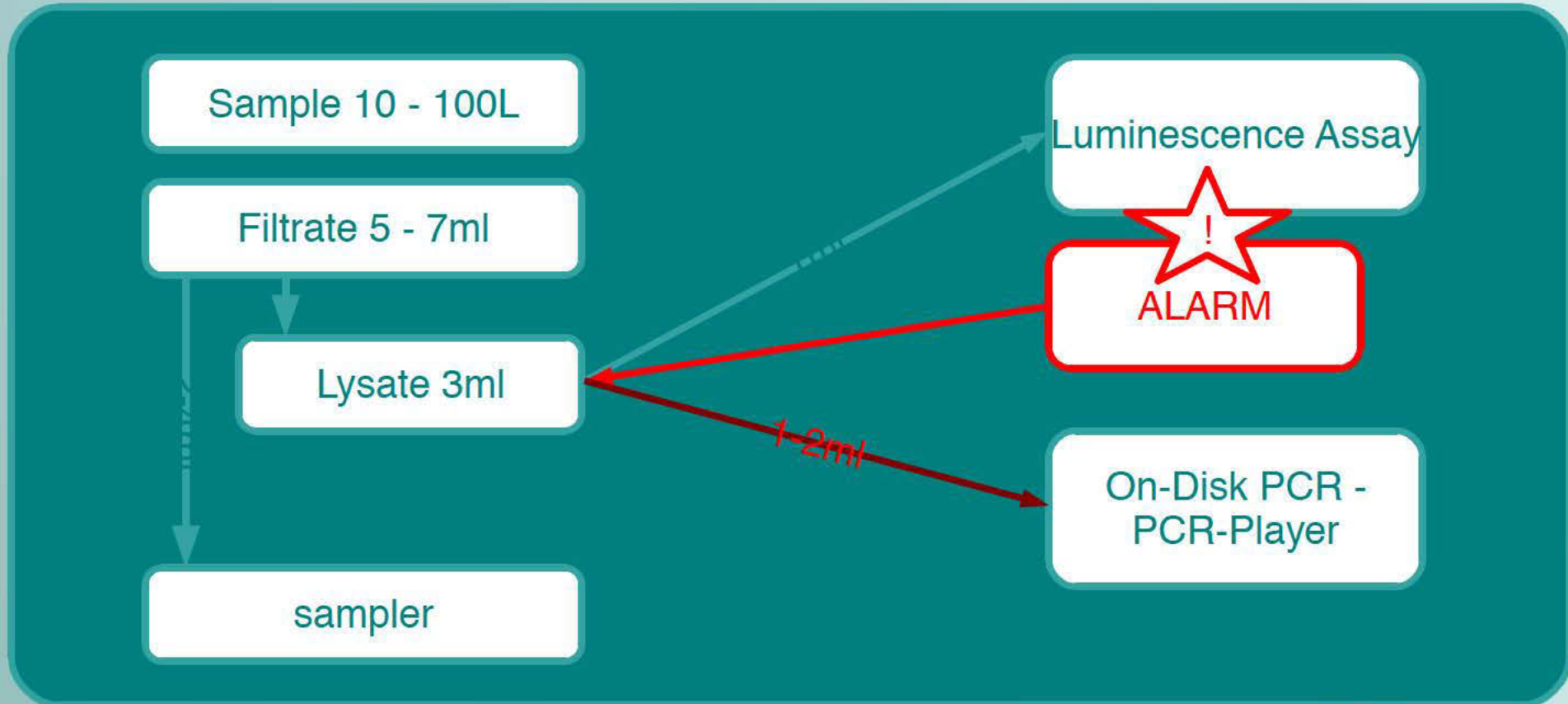

goals

concept

2-phase filtration module

Lysation of biological contaminants

Detector based on ATP-Assay

First test run in RWW water works

Additional sensor for PCR-Test

Lysation - ultrasound

3ml concentrate

10min time of sonification

50% power

50% interval

Heated lysator (70°C)



Bacteria and algae
are completely
sonified



goals

concept

2-phase filtration module

Lysation of biological contaminants

Detector based on ATP-Assay

First test run in RWW water works

Additional sensor for PCR-Test

Detection of bacterial ATP

Test runs online

Assay lasts >2 weeks and stays stable

Detection of very low concentrations of bacterial ATP

Software for alarm and data collection

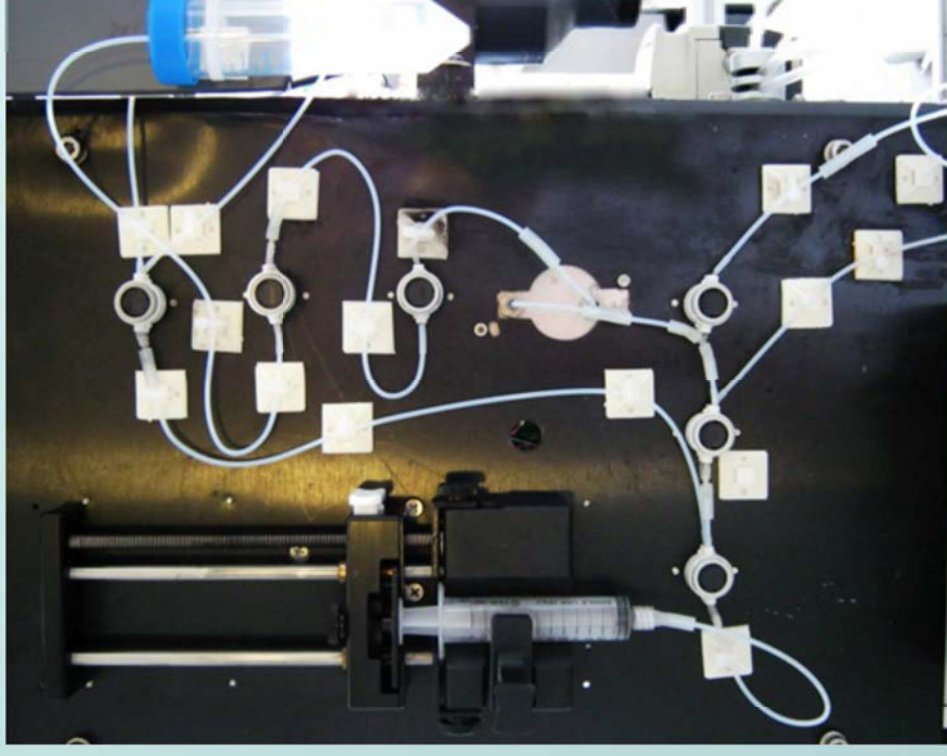

goals

concept

2-phase filtration module

Lysation of biological contaminants

Detector based on ATP-Assay

First test run in RWW water works

Additional sensor for PCR-Test

Test run of the device at RWW



Comparison to other methods

RWW-Laboratory

50ml sample from sample site

1ml of sample on agar plate

incubation at 20°C and 36°C

Incubation time 36h

Pathogen-detection

Connection to same sample site

Concentration of 50L of sample
within 60min

Lysis of the sample with ultrasound

Analysis for ATP in Luminescence
Assay

Long-term measurement

Messzeitraum 28.01. bis 05.02.2013

Probenvolumina 50L, alle 2:30h

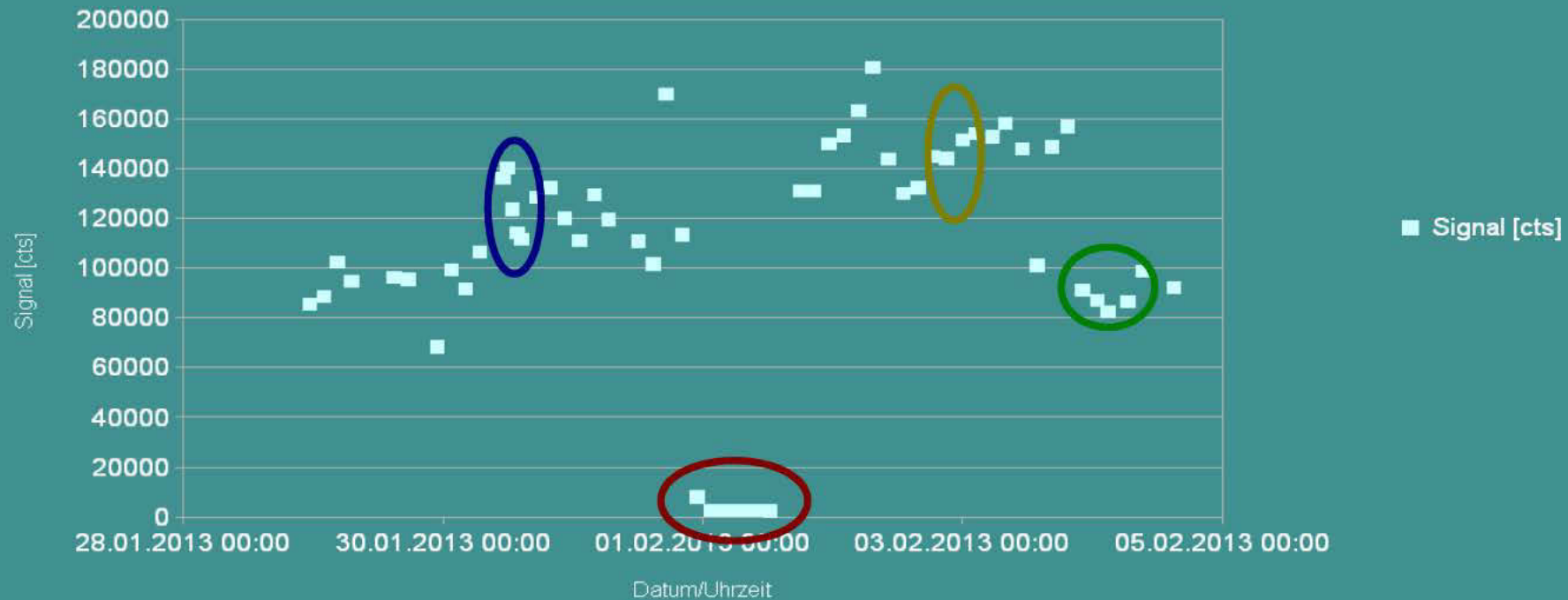

Dilution series

Lumineszenzsignal vs. Probenvolumen

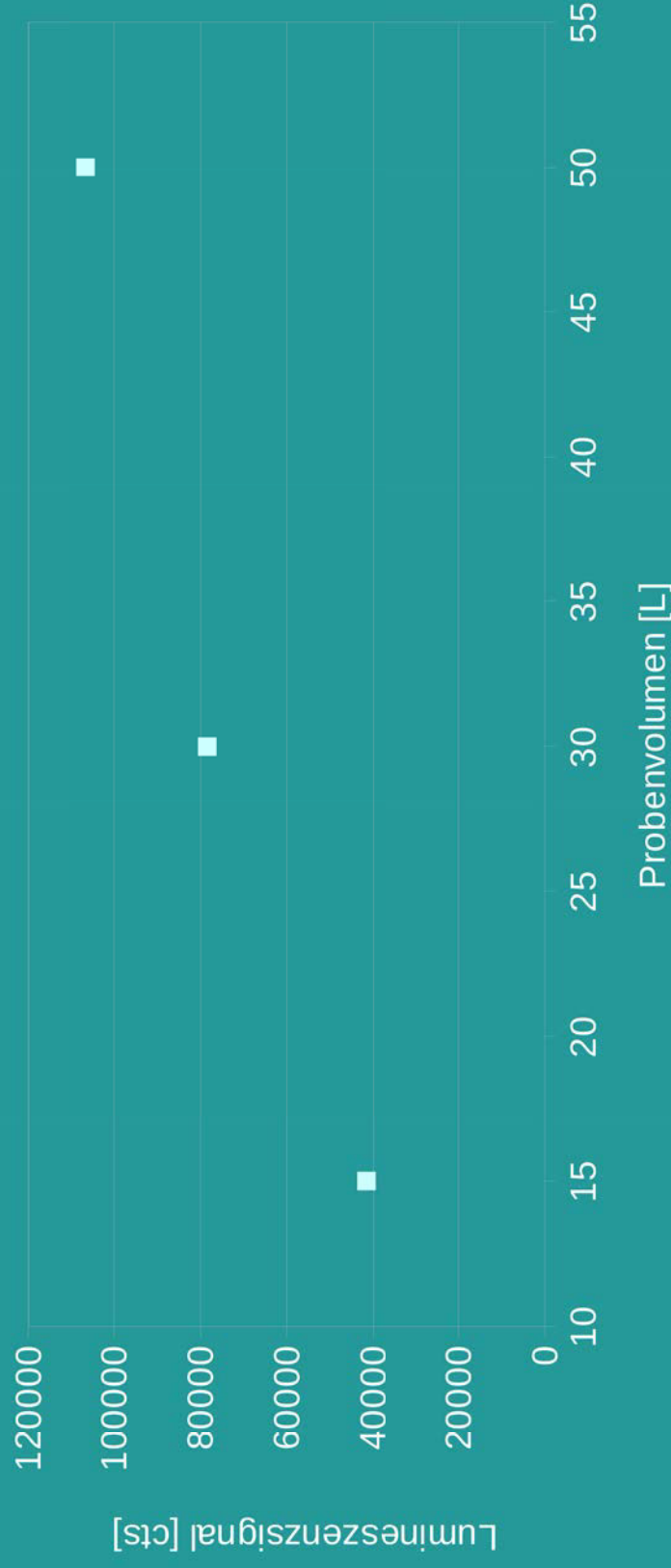

Comparison ATP-Assay vs. colonies

Koloniezahlen (Konzentrat) vs. Lumineszenzsignal

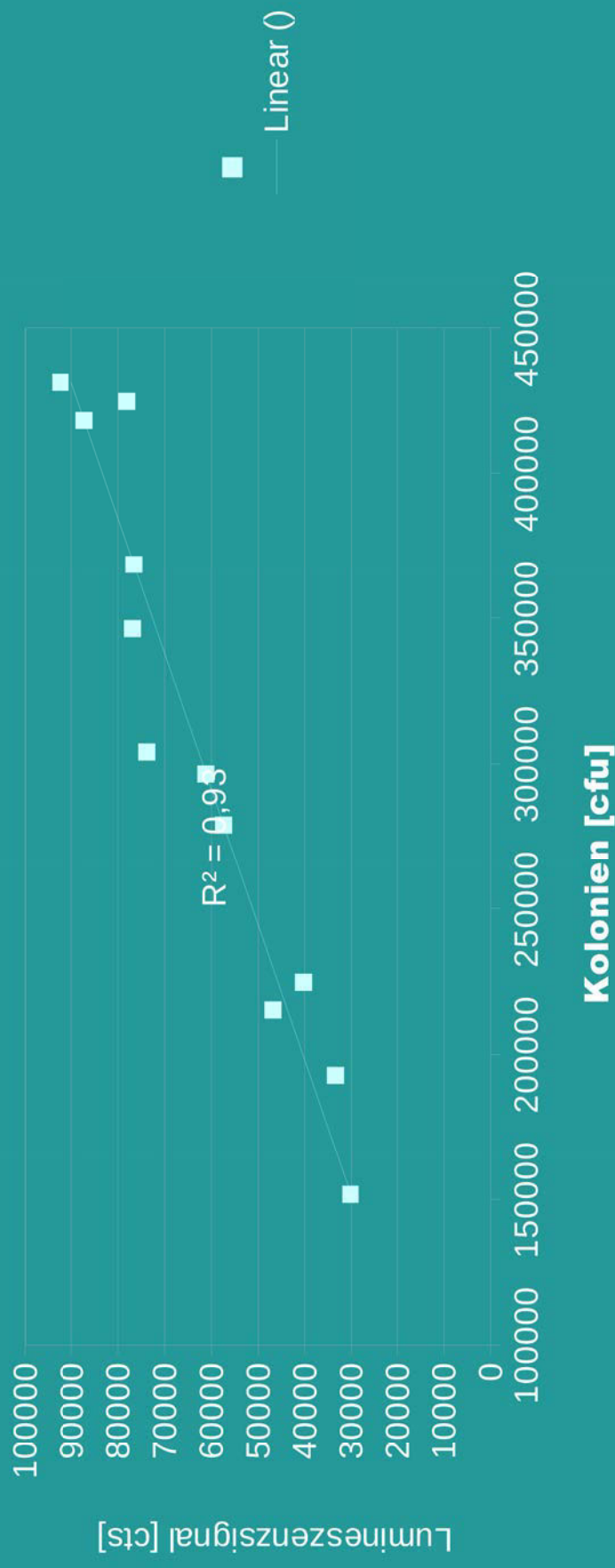

Filtration vs. standard sampling

Koloniezahlen (Konzentrat) vs. Koloniezahlen (Stichprobenuntersuchung)

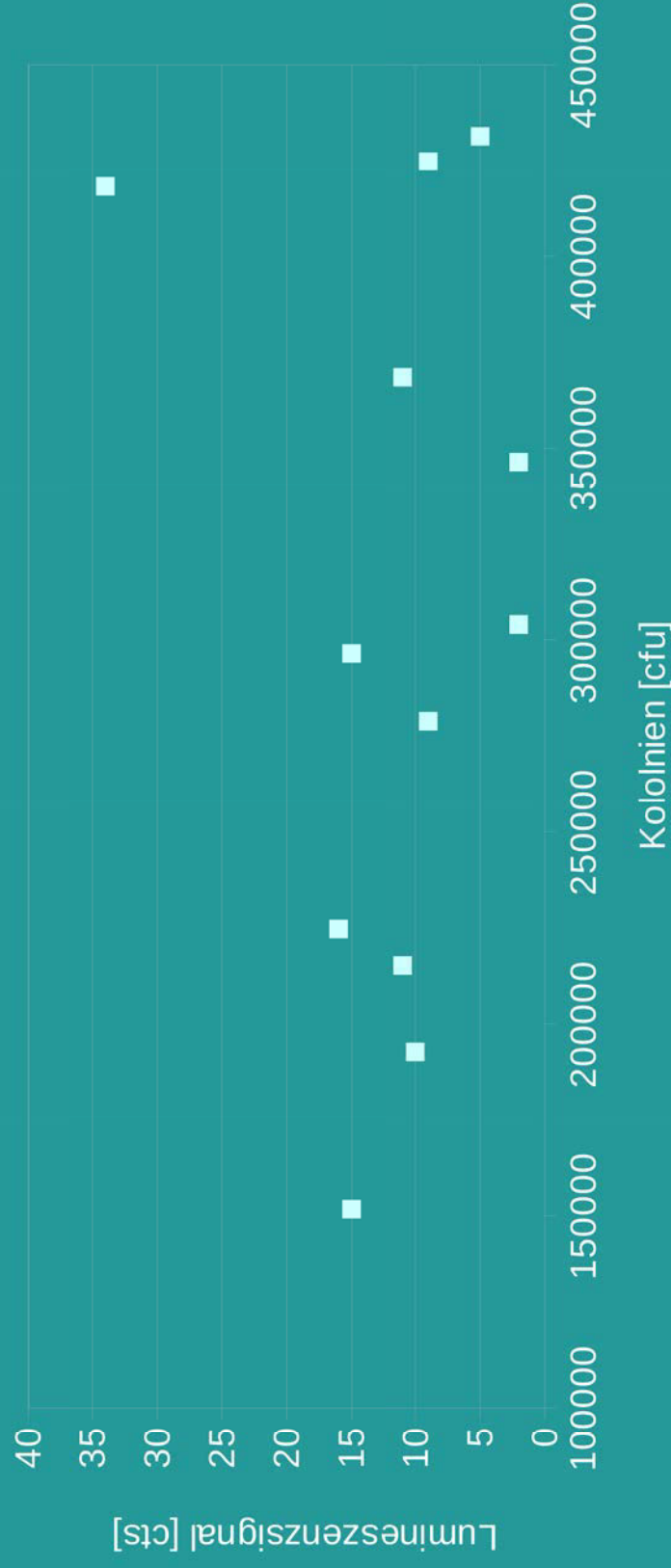

goals

concept

2-phase filtration module

Lysation of biological contaminants

Detector based on ATP-Assay

First test run in RWW water works

Additional sensor for PCR-Test

Adaptation of the PCR-Disk



Teachable robot

Control via PC through serial interface



Position of the dosing hole
Is freely adjustable

Dosing when luminescence
Signal tests positive

Something is moving...

Demonstration of the robot and the PCR-Player

Movie...

Software

Evaluation of the luminescence signal

Controlling the filtration

Control of the robot and the PCR-Player

Generates alarm when detecting pathogens

Nothing to see here ;)

prospect

- The tests with the demonstrator showed that it is possible to build such a device
- There is a group of potential applicants who would acquire such device if it meets their criteria
- If there is an interest in an online device for that application bbe is able to deliver a solution

