

bbe

biological · biophysical · engineering

moldaenke



www.bbe-moldaenke.de

AlgaeToximeter II

The all-rounder for the determination
of toxic substances in water



Universal
application area



Proven bbe
measurement
technology

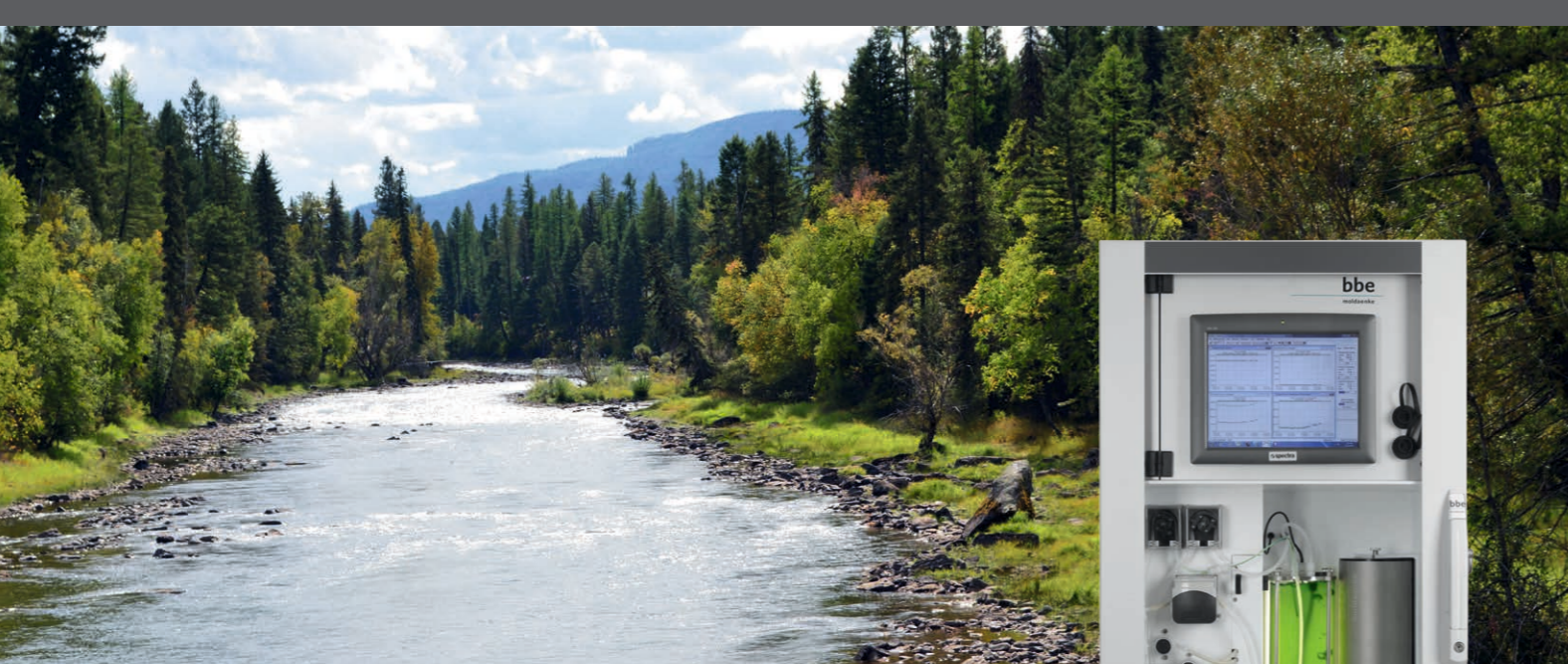

What does an algae toximeter do?

The AlgaeToximeter II is a biomonitor for the detection of pollutants and toxins in water

TASKS AND PERFORMANCE

- ▶ Checking the water quality
- ▶ Integration in existing test systems
- ▶ Detection of pollutants
- ▶ Use of proven test organisms
- ▶ Detection of acute toxicity
- ▶ Registration and evaluation of alarm situations
- ▶ Automated processes

Water is the most important natural resource in our world, and therefore life-determining for our existence and that of our descendants. Access to water of **sufficient quality** is part of basic human rights. Classic evaluation methods determine the biological or chemical oxygen demand of an aqueous sample as an indicator of water quality. This is not enough if there are toxic substances in the sample that can harm consumers and the environment. This is where **biological organisms help as indicators** of harmful substances. Biological indicators are organisms, which, due to their physiology, react to the presence of harmful substances. The damaging influence on the organism when in contact with a toxic or harmful substance (the toxicity) can be assessed. Of particular importance is the detection of **acute toxicity**, which develops its damaging effects after only a short period of exposure. Which organisms are suitable for this and how can they be used as biomonitors?

Suitable organisms include all organisms that are viable in water and whose reaction to the effects of pollutants can be clearly detected. **Microalgae** have these properties and have therefore been used in **bioassays** for decades. These tests evaluate the rate of microalgae reproduction after a predetermined period of 24 or 48 hours in previously collected discrete water samples. In the case of flowing water or water distribution systems, there are other requirements: **continuous monitoring** must be conducted in order to promptly identify sudden pulses of pollutants and take measures.

A delayed response time increases the risk of ecological and economic damage. In this case, the AlgaeToximeter II is used as a biomonitor. The **AlgaeToximeter II combines biological expertise with technical „know-how“**, using cultured microalgae in an automated apparatus for **quick pollutant detection**. In the presence of pollutants, the performance of the algae in the toximeter is impaired. Despite the unknown chemical composition of the sample, the toxicity is displayed within a short time. No chemical or physical analysis can do that. Even more: **an alarm is triggered** above a preset threshold value. The AlgaeToximeter II works **fully automatically 24/7** in online mode and also allows remote access.

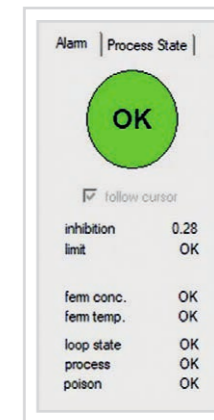

Clear status of toxicity detection in the bbe-Software

How does AlgaeToximeter II measure toxicity?

Fluorescence is the emission of light after the excitation of molecules. In algae, it is a natural process that takes place immediately upon exposure to sunlight or artificial light and results in a release of unused or excess energy. The light-collecting Photosystem II emits red light in the wavelength range from 685 - 700 nm. The intensities are recorded in the AlgaeToximeter and are a measure of the **physiological state of the algae**. The maximum efficiency or quantum yield of the radiation, which contributes to photosynthesis, is determined. This is closely linked to photosynthetic metabolism in algae and decreases under the influence of pollutants.

MEASUREMENTS

- ▶ Algae fluorescence
Quantenausbeute
- ▶ Quantum yield
- ▶ Sample processing
- ▶ Measurement process

An algae sample mixed with sample water is compared with a reference algal sample in reference water (unloaded sample). The **standardized algae** come from an integrated photobioreactor in the AlgaeToximeter. After dark adaptation, algae and sample water are pumped into a sensor which measures the fluorescence. The measurement begins with a dark incubation, during which the algae are converted into a basic state. With low light irradiation, the idle power of photosynthesis is measured as fluorescence (F0 light). Saturating strong light forces the maximum excitation and release of excess energy as Fm light. The ratio $Fm/F0$ gives the maximum quantum yield that can be used for photosynthesis. This value is also referred to as **activity** and is **between 0 and 1**, usually written as a percent. Productive green algae from the fermenter like *Chlorella vulgaris* achieve an activity of 65%. **Small amounts of pollutants significantly reduce this activity** (picture). The inhibition is determined by comparing the algae in sample water to the algae in reference water. The activity of those algae which naturally occur in the sample water is taken into account. The resulting activity value is a measure for the toxicity of the sample water. Fresh algae from the fermenter are used for each measurement. The measuring operation is quasi-continuous. A complete **measuring cycle lasts about 45 minutes** and is adjustable. All measurements are temperature controlled.

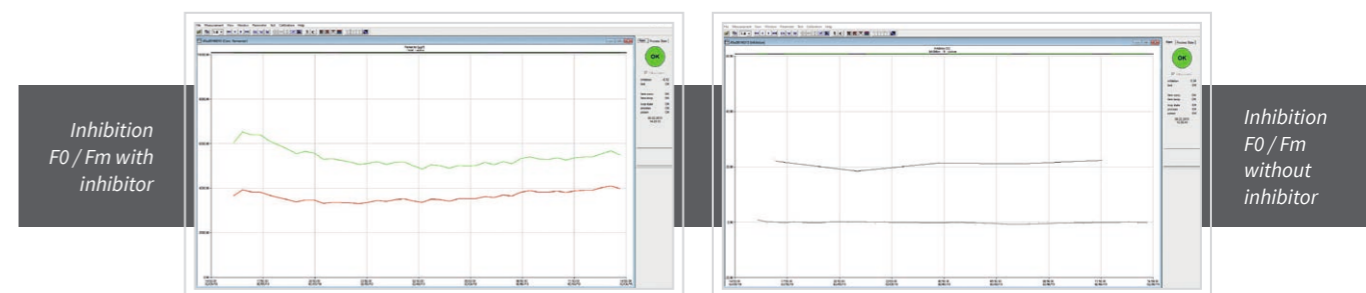



Additional data from AlgaeToximeter II

✓ CHARACTERISTICS

- ▶ Algae are stored directly in the device
- ▶ Suitable for fresh and sea water
- ▶ Algae class detection
- ▶ Blue-green algae detection
- ▶ Sample grinding
- ▶ Reference poison measurement
- ▶ Automatic cleaning of measuring chamber

What are the additional properties of AlgaeToximeter II?

The AlgaeToximeter II is **robust** in construction and operation: the **integrated fermenter** ensures a consistently high activity and quality of algae thanks to optimized growing conditions. For this purpose, both the algal concentration and activity **are checked constantly** and the nutrient supply is adjusted accordingly. The recommended microalgae (*Chlorella vulgaris*) are easy to grow and are proven toxicity indicator organisms according to the **ISO 8692: 2012** standard. Alternatively, other algal species can be used and thus adapted to **local requirements**.

The AlgaeToximeter II takes into account the naturally occurring algae in the sample water and corrects the determined activity values. The correction enables a **high level of accuracy** that cannot be achieved by other algae toximeters. The AlgaeToximeter II can be used with both freshwater algae and marine microalgae. This allows for effective monitoring of freshwater, coastal, and marine systems.

For use

The AlgaeToximeter II determines the **different algae classes in the sample** water and can therefore provide additional information on the occurrence of potentially harmful bluegreen algae. Depending on the version, it is available with dark adaptation via two upstream sample loops or with dark adaptation in the measuring chamber. The sample loops enable a **higher measuring frequency** by simultaneously incubating two samples. Alternatively, a dark adaptation in the measuring chamber improves the precision through simplified pump cycles.

The AlgaeToximeter II is available with a reference poison measurement for **quality assurance**. The inhibitory effect of an herbicide added to the reference algae is measured periodically. This allows the sensitivity of the algal toximeter to be rapidly checked. The sensor chamber is equipped with an **automatic cleaning device** that prevents the growth of biofilms and thus guarantees consistent measurement quality. The AlgaeToximeter II is a further development based on the AlgaeToximeter I, which has proven itself in continuous operation over more than 15 years.

Use, control and maintenance

The use of AlgaeToximeter II

The typical use of the algae toximeter is in a **measuring station**. The task is the **continuous monitoring** and recording of physical-chemical and biological data with the aim of recognizing harmful influences at an early stage, preventing them, or at least reducing them. The installation sites are linked to **water suppliers** (drinking water production and monitoring), **power plants**, **environmental authorities** (waters, rivers) and **sewage treatment plants** (after the last clarification stage). Ventilation with temperature adjustment (air conditioning) may be necessary for adequate use in some environments.

The AlgaeToximeter II is installed in a building or laboratory near a constant sample stream – often a ring line – from which the sample water to be examined is taken from a spill pot without pressure using a peristaltic pump. All other processes take place **automatically** in the AlgaeToximeter II. Canisters with nutrient solution are added to the algal toximeter, which supply the photobioreactor for approx. 1 week. After that, minor maintenance work and the renewal of the nutrient solutions are necessary. All continuous monitoring settings can be adjusted without the operator having direct access to the device. **Remote access** is usually linked to **integration into a higher-level network**. Thorough instruction and the designation of a responsible person (operator) enable smooth operation in cooperation with bbe Service.

Conclusion: Algae toximeters are used wherever potentially dangerous substances can occur, the type and composition of which are not known beforehand. In these cases, chemical analysis – especially continuous – would be almost unthinkable.

Maintenance of AlgaeToximeter II

Weekly: takes about 2 hours

- ▶ Check the inlets and outlets for blockages
- ▶ Replenish nutrient solution and reference poison
- ▶ Maintenance of algae culture, if necessary replacement with fresh algae
- ▶ Cleaning the hose system
- ▶ Exchange sample loops (depending on version)

For periodic maintenance work (½ or all year round) **maintenance contracts** are available with bbe Service.

+ ADDITIONAL APPLICATIONS

- ▶ Drinking water production and distribution
- ▶ Environmental monitoring in rivers and lakes
- ▶ Outflow from sewage treatment plants
- ▶ Remediation of contaminated sites

”

We have been using the algae toximeter online for more than 15 years. The biomonitors are an integral part of our early warning system.

“

Werner Blohm
Institute for Hygiene and Environment, City of Hamburg

↻ MAINTENANCE

- ▶ Controls
- ▶ Replacement
- ▶ Cleaning

Per month:

- ▶ Change the pump hoses

Twice annually:

- ▶ Fermenter cleaning and hose replacement

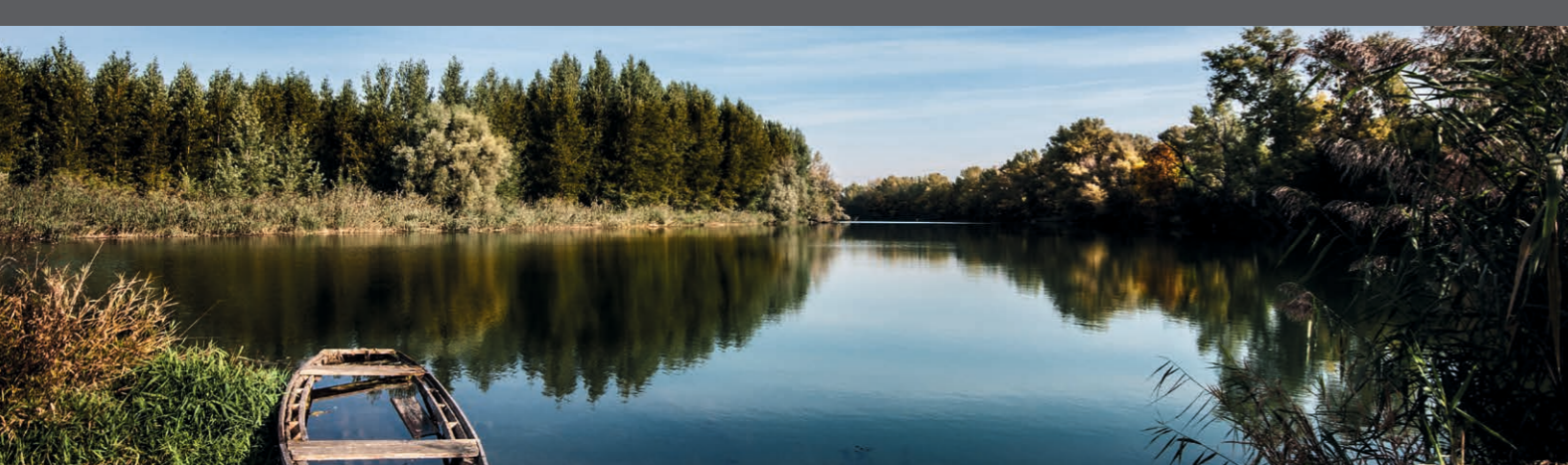

The components of AlgaeToximeter II

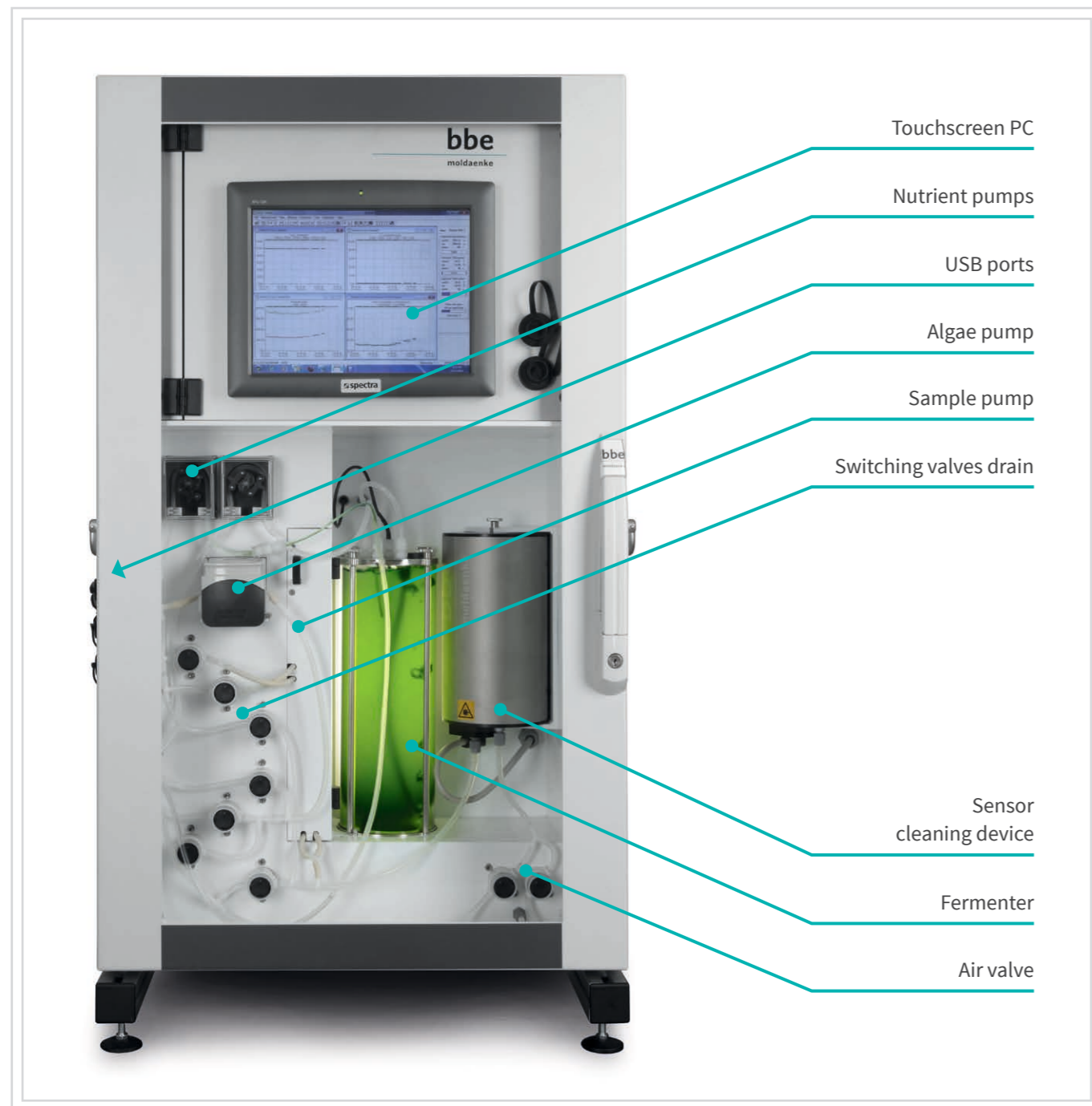

Components, software and background

The hose system with the components of AlgaeToximeter II

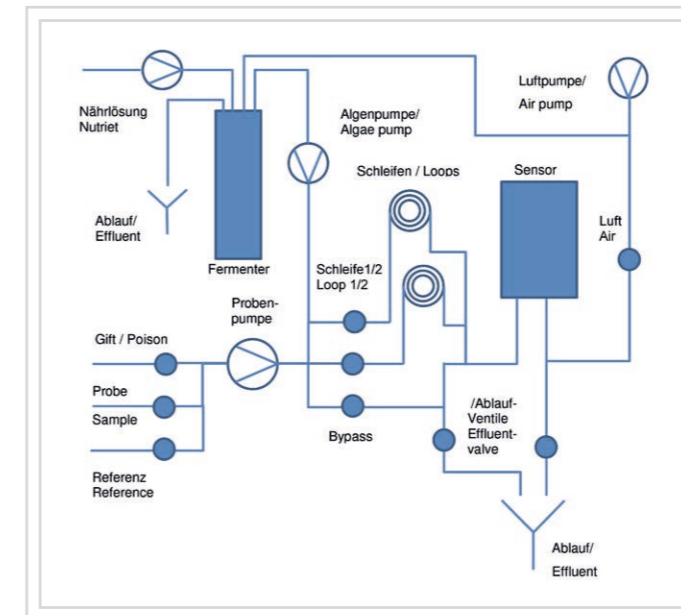

+ Background: what does an algal toximeter II detect?

Extensive studies on the toxicity of dangerous substances are recorded in the EU's "New Chemicals Database".

When compared to other test organisms, algae were very sensitive overall, albeit this statement says nothing about human toxicity. AlgaeToximeter II primarily records all substances that have a direct or indirect influence on Photosystem II. It is therefore understandable that the sensitivity to certain herbicides that act on photosynthesis is most pronounced (see picture below).

Microalgae are also acutely affected by cell-damaging toxic substances. Compared to daphnia and fish as test organisms, microalgae often show a higher sensitivity to aromatics, halogenated aromatics, chlorinated hydrocarbons, substituted organic acids, some heavy metals and surfactants. These are all substances that would hardly cause a reaction in other toxicity tests. The AlgaeToximeter II is designed to detect the toxicity of a very wide range of different substances and their mixtures. The type of chemical substance cannot be recognized with the AlgaeToximeter. A sample collector in connection with the AlgaeToximeter II is recommended for further analysis.

The software and the alarm detection

The automatic alarm detection in the AlgaeToximeter is carried out with the installed software and provides decisive advantages in the event of incidents involving toxins. Mathematical algorithms are used to continuously and automatically detect variability in the measured values. The software determines jumps in the measured value curve that lie outside the normal variability. Several of these deviations in succession verify the alarm threshold has been exceeded. However, changes are drift-compensated, so that a false alarm is prevented by simply exceeding a threshold value. This process guarantees reliable and timely alarm detection.

A calibration is not necessary because the measured value curve is continuously recorded and evaluated. The sensitivity of the toxicity measurement can be monitored periodically using a poison sample (e.g. herbicide).

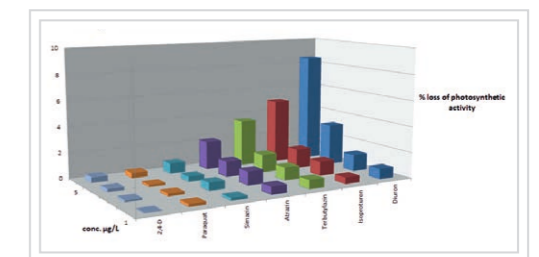

Inhibiting influence of various toxins on the algae in the AlgaeToximeter II.



SCOPE OF DELIVERY

- ▶ AlgaeToximeter II
- ▶ Syringe and tool
- ▶ Algae starter set
- ▶ Spare tubes
- ▶ Supply canister
- ▶ Dissolving nutrient
- ▶ USB keyboard
- ▶ Software
- ▶ 2nd independent plankton reactor

Optional:

- ▶ Sample loops
- ▶ Measurement with reference toxins
- ▶ 2nd independent plankton reactor



BENEFITS

- ▶ Broad, high sensitivity
- ▶ Established pollutant indicator
- ▶ Proven technology
- ▶ Long service life
- ▶ Low maintenance effort
- ▶ Autonomous fermenter
- ▶ Variable location
- ▶ Remote access and network capability

Technical details of AlgaeToximeter II

NAME	VALUES
Measured variables	Inhibition of photosynthesis, Total chlorophyll [$\mu\text{g Chl-a / l}$], Green algae concentration [$\mu\text{g Chl-a / l}$], Blue-green algae concentration [$\mu\text{g Chl-a / l}$], Diatom concentration [$\mu\text{g Chl-a / l}$], Cryptophyceae concentration [$\mu\text{g Chl-a / l}$], Yellow substances, Photosynthetic activity (Genty), Transmission (at 5 wavelengths)
Measuring range	0.3 - 500 $\mu\text{g Chl-a/l}$
Measurement method	spectral fluorometry
Temperature	0 - 50°C
Weight	160 kg
Dimensions (H x W x D)	1100 x 600 x 680 mm
Degree of protection	IP54
Voltage	110 - 240 V 50/60 Hz
Power	600 W
Sample temperature	5 - 30°C
Sample volume	30 ml
Internal PC	HD, LCD display, DVD, USB
Maintenance interval	> 7 days
Outputs	modem, LAN, 2 x analog output 4 - 20 mA, 2 x relay output, RS232



Sample water is mixed with the algae test solution and then analyzed

Do you have any questions? Please contact us!

Your local representative

bbe

biological · biophysical · engineering

moldaenke

bbe Moldaenke GmbH

Preetzer Chaussee 177
24222 Schwentinental
Germany

Tel.: +49 (0) 431 - 380 40-0
Fax: +49 (0) 431 - 380 40-10
bbe@moldaenke.de

